

AIR-COOLED LIQUID CHILLERS, REVERSIBLE AIR-TO-WATER HEAT PUMPS



Commercial and industrial
applications

Compact design

Quiet operation

Variable water flow

Partial heat reclaim

30RBS 039-160 C 30RQS 039-160 B

AQUASNAP[®]

Nominal cooling capacity 30RBS: 40-156 kW
Nominal cooling capacity 30RQS: 38-148 kW
Nominal heating capacity 30RQS: 42-150 kW

The Aquasnap range of liquid chillers/air-to-water heat pumps was designed for commercial (air conditioning of offices, hotels etc.) or industrial (low-temperature process units etc.) applications.

The Aquasnap integrates the latest technological innovations:

- Ozone-friendly refrigerant R410A
- All-aluminium microchannel heat exchangers for the cooling only units (30RBS)
- Scroll compressors
- Low-noise fans made of a composite material
- Auto-adaptive microprocessor control
- Electronic expansion valve
- Variable-speed pump (option)

The Aquasnap can be equipped with a hydraulic module integrated into the unit chassis, limiting the installation to straightforward operations like connection of the power supply and the chilled water supply and return piping.



CARRIER participates in the ECP programme for LCP/HP
Check ongoing validity of certificate:
www.eurovent-certification.com

FEATURES

Quiet operation

- Compressors
 - Low-noise scroll compressors with low vibration level
 - The compressor assembly is installed on an independent chassis and supported by anti-vibration mountings
 - Dynamic suction and discharge piping support, minimising vibration transmission (Carrier patent).
- Condenser (30RBS)/air evaporator/condenser (30RQS) section
 - Vertical condenser coils
 - Anti-vibration mountings and optional grilles to protect the heat exchanger against possible shocks.
 - Low-noise latest-generation Flying Bird IV fans, made of a composite material (Carrier patent) are now even quieter and do not generate intrusive low-frequency noise
 - Rigid fan installation for reduced start-up noise (Carrier patent).

Easy and fast installation

- Integrated hydraulic module (option)
 - Centrifugal low or high-pressure water pump (as required), based on the pressure loss of the hydraulic installation

Hydraulic module



- Single or dual water pump (as required) with operating time balancing and automatic changeover to the back-up pump if a fault develops
- Water filter protects the pump against circulating debris
- Pressure measurement, using two pressure transducers and allowing indication of water flow rate, water pressure and lack of water.
- High-capacity membrane expansion tank ensures pressurisation of the water circuit
- Overpressure valve, set to 4 bar
- Speed variator on the pumps (option) to ensure the correct flow rate, based on the system requirements
- Thermal insulation and frost protection down to -20°C, using an electric resistance heater (see table of options)
- Physical features
 - The unit has a small footprint and a low height (1330 mm) allowing it to blend in with any architectural styles.
 - The unit is enclosed by easily removable panels, covering all components (except air heat exchangers and fans).
- Simplified electrical connections
 - A single power supply point without neutral
 - Main disconnect switch (option 70) with high trip capacity
 - Transformer for safe 24 V control circuit supply included

- Fast commissioning
 - Systematic factory operation test before shipment
 - Quick-test function for step-by-step verification of the instruments, electrical components and motors.

Economical operation

- Optional variable-speed pump for economical operation
- The control algorithm adjusts the water flow rate based on the actual system requirements and obsoletes the need for the control valve at the unit outlet.
- Increased energy efficiency at part load
 - The refrigerant circuit includes several compressors connected in parallel. At part load, around 99% of the operating time, only the compressors that are absolutely necessary operate. At these conditions the compressors operating are more energy efficient, as they use the total condenser and evaporator capacity.
 - The electronic expansion device (EXV) allows operation at a lower condensing pressure (SEER and SCOP Seasonal performances optimisation).
 - Dynamic superheat management for better utilisation of the water heat exchanger surface.
 - Defrost cycle optimisation (30RQS).
- Reduced maintenance costs
 - Maintenance-free scroll compressors
 - Fast diagnosis of possible incidents and their history via the Touch Pilot Junior control
 - R410A refrigerant is easier to use than other refrigerant blends.

Environmental care

- Ozone-friendly R410A refrigerant
 - Chlorine-free refrigerant of the HFC group with zero ozone depletion potential
 - Very efficient - gives an increased energy efficiency ratio
 - 50% reduction in the refrigerant charge through the use of micro-channel heat exchangers for the cooling only units (30RBS)
- Leak-tight refrigerant circuit
 - Brazed refrigerant connections for increased leak-tightness
 - Reduction of leaks due to reduced vibration levels and elimination of capillary tubes (TXVs)
 - Verification of pressure transducers and temperature sensors without transferring refrigerant charge.

Partial view of the hydraulic circuit

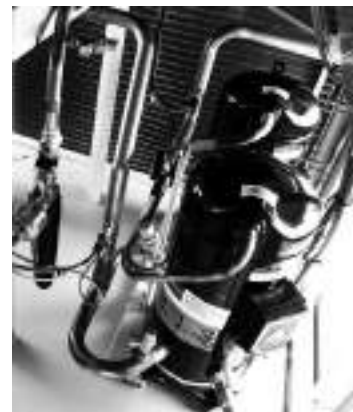

FEATURES

Superior reliability

- State-of-the-art concept
 - Cooperation with specialist laboratories and use of limit simulation tools (finite element calculations) for the design of the critical components, e.g. motor supports, suction/discharge piping etc.
 - All aluminium micro-channel heat exchanger (MCHE) on cooling only units (30RBS), offers increased corrosion resistance compared to traditional coils. The all-aluminium design eliminates the formation of galvanic currents between aluminium and copper that cause coil corrosion.
- Auto-adaptive control
 - Control algorithm prevents excessive compressor cycling and permits reduction of the water quantity in the hydraulic circuit (Carrier patent)
 - Hydraulic module with integrated pressure transducers allowing measurement of the water pressure at two points, as well as measurement of the water flow rate and detection of lack of water and pressure. This considerably reduces the risk of problems such as frost accumulation on the water heat exchanger.
 - Automatic compressor unloading in case of abnormally high condensing pressure. If an anomaly occurs (e.g. fouled air heat exchanger coil, fan failure) Aquasnap continues to operate, but at reduced capacity.
 - On Heat pump version 30RQS specific Free Defrost algorithm to optimise performance and comfort even during defrost period.
- Exceptional endurance tests
 - Corrosion resistance tests in salt mist in the laboratory
 - Accelerated ageing test on components that are submitted to continuous operation: compressor piping, fan supports
 - Transport simulation test in the laboratory on a vibrating table.

Touch Pilot Junior control

The Touch Pilot Junior features a control with advanced communication technology over Ethernet (IP), user-friendly and intuitive user interface with 4.3" colour touch screen.

- Energy management
 - Internal time schedule clock: Controls heat pump on/off times and operation at a second set-point
 - Set-point offset based on the outside air temperature
 - Master/slave control of two heat pumps operating in parallel with operating time equalisation and automatic change-over in case of a unit fault.
- Integrated advanced communication features
 - Night mode: Capacity and fan speed limitation for reduced noise level
 - With hydraulic module: Water pressure display and water flow rate calculation
 - Easy and high-speed communication technology over Ethernet (IP) to a building management system
 - Access to multiple unit parameters.
 - Without hydraulic module: 0-10V output is available for external variable speed pump control

- 4.3" Touch Pilot Junior user interface

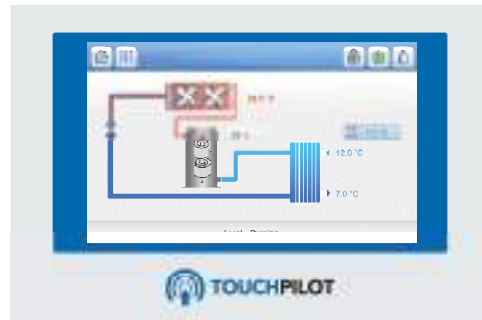

- Intuitive and user-friendly 4.3 inch touch screen interface
- Concise and clear information is available in local languages
- Complete menu, customised for different users (end user, service personnel or Carrier engineers).

Remote management (standard)

Units with Touch Pilot Junior control can be easily accessed from the internet, using a PC with an Ethernet connection. This makes remote control quick and easy and offers significant advantages for service operations.

The Aquasnap is equipped with an RS485 serial port that offers multiple remote control, monitoring and diagnostic possibilities. Carrier offers a vast choice of control products, specially designed to control, manage and supervise the operation of an air conditioning system. Please consult your Carrier representative for more information.

The Aquasnap also communicates with other building management systems via optional communication gateways.

A connection terminal allows remote control of the Aquasnap by wired cable:

- Start/stop: Opening of this contact will shut down the unit
- Dual set-point: Closing of this contact activates a second set-point (example: unoccupied mode).
- Demand limit: Closing of this contact limits the maximum heat pump capacity to a predefined value.
- Operation indication: This volt-free contact indicates that the heat pump is operating (cooling load).
- Alarm indication: This volt-free contact indicates the presence of a major fault that has led to the shut-down of one or several refrigerant circuits.

Flying Bird IV fan



FEATURES

All-aluminium micro-channel heat exchanger (MCHE)



Already utilised in the automobile and aeronautical industries for many years, the MCHE micro-channel heat exchanger is entirely made of aluminium. This one-piece concept significantly increases its corrosion resistance by eliminating the galvanic currents that are created when two different metals (copper and aluminium) come into contact in traditional heat exchangers.

As an option, the Enviro-Shield and Super Enviro-Shield anti-corrosion protections have been developed to increase the application range of the MCHE coil from medium to very corrosive environments. With Enviro-Shield protection, corrosion resistance of the MCHE coil is doubled without any impact on heat exchange.

With Super Enviro-Shield protection corrosion resistance of the MCHE coil is multiplied by four, and allows use in very corrosive industrial or marine environments

The MCHE heat exchanger allows a reduction in chiller refrigerant charge by up to 50%.

The low thickness of the MCHE reduces air pressure losses by 50% and makes it less susceptible to fouling (e.g. by sand) than a traditional coil. Cleaning of the MCHE heat exchanger is very fast using a dry air jet or a high-pressure washer, while observing the usage precautions.

OPTIONS

Options	No.	Description	Advantages	Use
Corrosion protection, traditional coils	3A	Fins made of pre-treated aluminium (polyurethane and epoxy)	Improved corrosion resistance, recommended for moderate marine and urban environments	30RQS 039-160
Medium-temperature brine solution	5B	Low temperature chilled water production down to 0°C with ethylene glycol and propylene glycol.	Covers specific applications such as ice storage and industrial processes	30RBS/ 30RQS 039-160
Low-temperature brine solution	6B	Low temperature chilled water production down to -15°C with ethylene glycol and -12°C with propylene glycol.	Covers specific applications such as ice storage and industrial processes	30RBS/ 30RQS 039-160
Very low noise level	15LS	Acoustic compressor enclosure and low-speed fans	Noise emission reduction at reduces fan speed	30RBS/ 30RQS 039-160
Protection grilles	23	Metallic protection grilles	Coil protection against possible impact	30RBS/ 30RQS 039-160
Soft Starter	25	Electronic starter on each compressor	Reduced start-up current	30RBS/ 30RQS 039-160
Winter operation down to -20°C	28	Fan speed control via frequency converter	Stable unit operation when the air temperature is between -10°C and -20°C.	30RBS/ 30RQS 039-160
Frost protection down to -20°C	42	Electric heater on the hydraulic module	Hydraulic module frost protection at low outside temperatures	30RBS/ 30RQS 039-160
Partial heat recovery	49	Unit equipped with one desuperheater on each refrigerant circuit.	Production of free high-temperature hot-water simultaneously with chilled water production (or hot water for Heat pump)	30RBS/ 30RQS 039-160
Master/slave operation	58	Unit equipped with supplementary water outlet temperature sensor kit to be field-installed allowing master/slave operation of two units connected in parallel	Optimised operation of two units connected in parrallele operation with operating time equalisation	30RBS/ 30RQS 039-160
Main disconnect switch without fuse	70	Factory-installed main electric disconnect switch in the control box	Ease-of-installation and compliance with local electrical regulations	30RBS/ 30RQS 039-160
HP single-pump hydraulic module	116R	Single high-pressure water pump, water filter, electronic water flow control, pressure transducers. For more details, refer to the dedicated chapter (expansion tank not included.Option with built-in safety hydraulic components available.)	Easy and fast installation (plug & play)	30RBS (Brine only)/ 30RQS 039-160
HP dual-pump hydraulic module	116S	Dual high-pressure water pump, water filter, electronic water flow control, pressure transducers. For more details, refer to the dedicated chapter (expansion tank not included) Option with built-in safety hydraulic components available)	Easy and fast installation (plug & play)	30RBS (Brine only)/ 30RQS 039-160
LP single-pump hydraulic module	116T	Single low-pressure water pump, water filter, electronic water flow control, pressure transducers. For more details, refer to the dedicated chapter (expansion tank not included Option with built-in safety hydraulic components available)	Easy and fast installation (plug & play)	30RQS 039-160
LP dual-pump hydraulic module	116U	Dual low-pressure water pump, water filter, electronic water flow control, pressure transducers. For more details, refer to the dedicated chapter (expansion tank not included Option with built-in safety hydraulic components available)	Easy and fast installation (plug & play)	30RQS 039-160
HP variable-speed single-pump hydraulic mod.	116V	Single high-pressure water pump with variable speed drive (VSD), water filter, electronic water flow control, pressure transducers. Multiple possibilities of water flow control. For more details, refer to the dedicated chapter (expansion tank not included Option with built-in safety hydraulic components available)	Easy and fast installation (plug & play), significant pumping energy cost savings (more than two-thirds), tighter water flow control, improved sytem reliability	30RBS/ 30RQS 039-160

OPTIONS

Options	No.	Description	Advantages	Use
HP variable-speed dual-pump hydraulic mod.	116W	Dual high-pressure water pump with variable speed drive (VSD), water filter, electronic flow switch, pressure transducers. Multiple possibilities of water flow control. For more details, refer to the dedicated chapter (expansion tank not included Option with built-in safety hydraulic components available)	Easy and fast installation (plug & play), significant pumping energy cost savings (more than two-thirds), tighter water flow control, improved system reliability	30RBS/ 30RQS 039-160
J-Bus gateway	148B	Two-directional communication board complying with JBus protocol	Connects the unit by communication bus to a building management system	30RBS/ 30RQS 039-160
Lon gateway	148D	Two-directional communication board complying with Lon Talk protocol	Connects the unit by communication bus to a building management system	30RBS/ 30RQS 039-160
Bacnet over IP	149	Two-directional high-speed communication using BACnet protocol over Ethernet network (IP)	Easy and high-speed connection by ethernet line to a building management system. Allows access to multiple unit parameters	30RBS/ 30RQS 039-160
External boiler management	156a	Control board factory-installed on the unit to control a boiler	Extended remote control capabilities to a boiler on/off command. Permits easy control of a basic heating system	30RQS 039-160
Electric heaters management	156b	Control board factory-installed on the unit with additional inputs/outputs in order to manage up to 4 external heating stage (electrical heaters...)	Extended remote control capabilities to up to 4 electric heaters. Permits easy control of a basic heating system	30RQS 039-160
Compliance with Russian regulations	199	EAC certification	Conformance with Russian regulations	30RBS/ 30RQS 039-160
Enviro-Shield anti-corrosion protection	262	Coating by conversion process which modifies the surface of the aluminum producing a coating that is integral to the coil. Complete immersion in a bath to ensure 100% coverage. No heat transfer variation, tested 4000 hours salt spray per ASTM B117	Improved corrosion resistance, recommended for use in moderately corrosive environments	30RBS 039-160
Super Enviro-Shield anti-corrosion protection	263	Extremely durable and flexible epoxy polymer coating applied on micro channel heat exchangers by electro coating process, final UV protective topcoat. Minimal heat transfer variation, tested 6000 hours constant neutral salt spray per ASTM B117, superior impact resistance per ASTM D2794	Improved corrosion resistance, recommended for use in extremely corrosive environments	30RBS 039-160
Evaporator screw connection sleeves	264	Evaporator inlet/outlet screw connection sleeves	Allows unit connection to a screw connector	30RBS/ 30RQS 039-160
Welded evaporator connection kit	266	Victaulic piping connections with welded joints	Easy installation	30RBS/ 30RQS 039-160
Reinforced ECM filtration for fan VFD	282A	Fan variable frequency drive compliance to IEC 61800-3 C1 class	Allows unit installation in domestic residential environment by reducing electromagnetic interferences	30RBS/ 30RQS 039-160 with option 5B, 6B or 28
Reinforced ECM filtration for pump VFD	282B	Pump variable frequency drive compliance to IEC 61800-3 C1 class	Allows unit installation in domestic residential environment by reducing electromagnetic interferences	30RBS/ 30RQS 039-160 with option 116V or 116W
Expansion tank	293	6 bar expansion tank integrated in the hydraulic module (require option 116)	Easy and fast installation (plug & play), & Protection of closed water systems from excessive pressure	30RBS/ 30RQS 039-160
Set point adjustment by 4-20mA signal	311	Connections to allow a 4-20mA signal input	Easy energy management, allow to adjust set point by a 4-20mA external signal	30RBS/ 30RQS 039-160
Free Cooling dry cooler management	313	Control & connections to a Free Cooling Drycooler 09PE or 09VE fitted with option FC control box	Easy system management, Extended control capabilities to a drycooler used in Free Cooling mode	30RBS 039-160

BRINE OPTIONS (OPTION 5B & OPTION 6B)

This option allows production of brine down to 0°C (option 5B) / -15°C (option 6B). The unit is equipped with suction pipe insulation (option 6B only) and a fan frequency converter.

The operating range is a function of the suction pressure, which in turn is a function of:

- The brine type
- The brine concentration
- The flow rate
- The brine temperature
- The condensing pressure (ambient temperature).

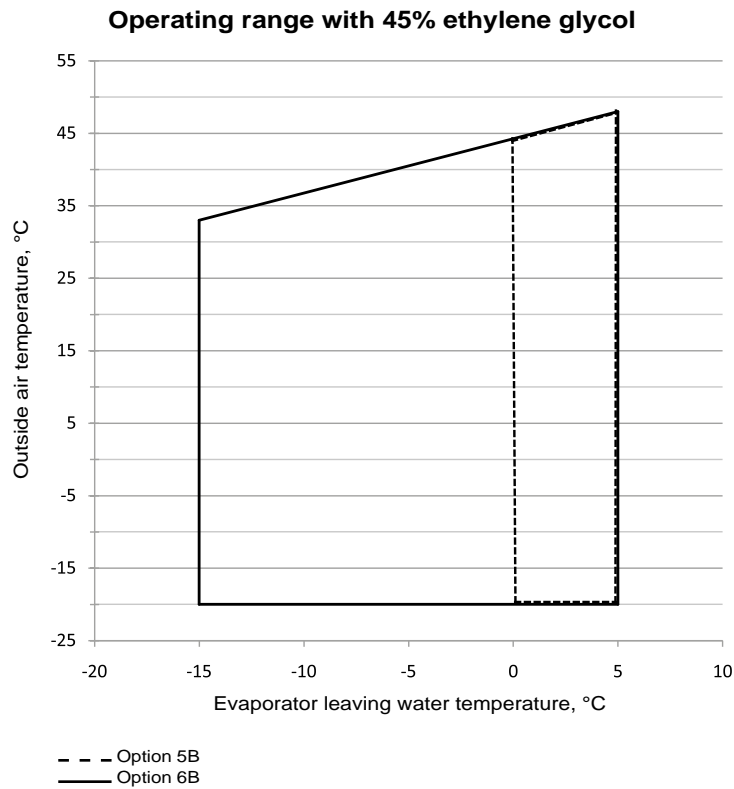

PARTIAL HEAT RECLAIM USING DESUPERHEATERS (OPTION 49)

This option permits the production of free hot water using heat reclaim by desuperheating the compressor discharge gases. The option is available for the whole 30RBS/RQS range.

A plate heat exchanger is installed in series with the air condenser coils on the compressor discharge line of each circuit.

Physical data, 30RBS units with partial heat reclaim using desuperheaters (option 49)

30RBS partial heat reclaim mode		039	045	050	060	070	080	090	100	120	140	160
Operating weight 30RBS units with MCHE coils⁽¹⁾												
Standard unit without hydraulic module	kg	437	444	448	468	467	492	784	793	830	929	964
Standard unit with hydraulic module option												
Single high-pressure pump	kg	467	474	478	498	497	515	854	815	831	968	1003
Dual high-pressure pump	kg	493	500	504	524	522	541	861	870	914	1005	1040
Refrigerant charge, units with MCHE coils												
R-410A												
Circuit A	kg	4,7	5,3	5,9	6,7	6,2	7,3	10,7	10,8	11,4	6,5	7,4
Circuit B	kg	-	-	-	-	-	-	-	-	-	6,5	7,4
Condensers												
All aluminium microchannel heat exchanger (MCHE)												
Desuperheaters on circuits A and B												
Plate heat exchangers												
Water volume, circuit A	l	0.549	0.549	0.549	0.549	0.732	0.732	0.976	0.976	0.976	0.732	0.732
Water volume, circuit B	l	-	-	-	-	-	-	-	-	-	0.732	0.732
Max. water-side operating pressure without hydraulic module	kPa	1000	1000	1000	1000	1000	1000	1000	1000	1000	1000	1000
Water connections												
Cylindrical, male gas thread												
Connections	in	1	1	1	1	1	1	1	1	1	1	1
Outside diameter	mm	42	42	42	42	42	42	42	42	42	42	42

(1) Weights shown are a guideline only.

Physical data, 30RQS units with partial heat reclaim using desuperheaters (option 49)

30RQS partial heat reclaim mode		039	045	050	060	070	078	080	090	100	120	140	160
Operating weight units with RTPF coils⁽¹⁾													
Standard unit without hydraulic module	kg	507	514	542	555	556	563	749	896	904	962	1073	1091
Standard unit with hydraulic module option													
Single high-pressure pump	kg	563	544	572	585	585	593	779	928	936	998	1112	1130
Dual high-pressure pump	kg	562	570	597	611	611	619	805	973	981	1046	1149	1167
Refrigerant charge, units with RTPF coils													
R-410A													
Circuit A	kg	12.5	13.5	16.5	17.5	18.0	16.5	21.5	27.5	28.5	33.0	19.0	18.5
Circuit B	kg	-	-	-	-	-	-	-	-	-	-	19.0	18.5
Condensers													
Grooved copper tubes. aluminium fins													
Desuperheaters on circuits A and B													
Plate heat exchangers													
Water volume, circuit A	l	0.549	0.549	0.549	0.732	0.732	0.732	0.732	0.976	0.976	0.976	0.732	0.732
Water volume, circuit B	l	-	-	-	-	-	-	-	-	-	-	0.732	0.732
Max. water-side operating pressure without hydraulic module	kPa	1000	1000	1000	1000	1000	1000	1000	1000	1000	1000	1000	1000
Water connections													
Cylindrical, male gas thread													
Connections	in	1	1	1	1	1	1	1	1	1	1	1	1
Outside diameter	mm	42	42	42	42	42	42	42	42	42	42	42	34

(1) Weights shown are a guideline only.

Operating limits

Desuperheater		Minimum	Maximum
Entering water temperature at start-up	°C	25 ⁽¹⁾	60
Leaving water temperature during operation	°C	30	65
Air condenser		Minimum	Maximum
Outside air temperature	°C	-10	46

(1) The entering water temperature at start-up must not be lower than 25°C. For installations with a lower temperature a three-way valve is necessary.

RECLAIMED HEATING CAPACITIES USING DESUPERHEATER(S)

30RBS 039-160

30RBS 039-160	Desuperheater entering water temperature, °C								
	45			50			55		
	Qhr	q	Δp	Qhr	q	Δp	Qc	q	Δp
	kW	l/s	kPa	kW	l/s	kPa	kW	l/s	kPa
039	12.9	0.31	6.1	10.9	0.26	4.4	9.0	0.21	3.1
045	16.5	0.40	9.5	14.3	0.34	7.4	12.0	0.29	5.2
050	18.1	0.43	11.7	15.4	0.37	8.5	12.8	0.31	6.1
060	19.3	0.46	12.9	16.6	0.40	9.8	13.7	0.33	6.9
070	24.3	0.58	11.8	21.0	0.50	9.2	17.5	0.42	6.5
080	28.6	0.68	16.3	24.4	0.58	12.1	20.6	0.49	8.8
090	30.5	0.73	11.4	25.8	0.62	8.2	21.5	0.51	5.8
100	36.4	0.87	16.0	31.9	0.76	12.4	27.0	0.64	8.9
120	43.1	1.03	22.6	37.4	0.89	17.2	31.6	0.75	12.3
140 ⁽¹⁾	47.1	1.12	11.3	39.7	0.95	8.3	33.0	0.79	5.9
160 ⁽¹⁾	54.0	1.29	15.0	45.6	1.09	10.7	38.3	0.92	7.8

Legend

Qhr Total heating capacity reclaimed at the desuperheater(s), kW

q Total water flow rate in the desuperheater loop, l/s

Δp Pressure drop per desuperheater, kPa

(1) Sizes 140 and 160 are fitted with 2 desuperheaters, one per circuit.

Application data

Evaporator entering/leaving water temperature 12/7°C

Outside air temperature 35°C

Desuperheater entering/leaving water temperature difference 10 K

Evaporator fluid: Chilled water

Fouling factor 0.18×10^{-4} (m² K)/W

30RQS 039-160 cooling mode

30RQS 039-160	Desuperheater entering water temperature, °C								
	45			50			55		
	Qhr	q	Δp	Qhr	q	Δp	Qc	q	Δp
	kW	l/s	kPa	kW	l/s	kPa	kW	l/s	kPa
039	10.9	0.26	4.4	9.1	0.22	3.1	7.1	0.18	2.1
045	14.4	0.34	7.5	12.2	0.29	5.4	10.0	0.24	3.7
050	17.2	0.41	10.5	14.7	0.35	7.8	12.3	0.29	5.6
060	17.4	0.44	6.6	15.1	0.36	4.6	12.3	0.29	3.0
070	21.4	0.51	9.3	17.9	0.43	6.7	14.7	0.35	4.8
078	26.8	0.64	14.7	22.5	0.54	10.4	18.8	0.45	7.5
080	23.9	0.57	12.1	21.2	0.51	7.8	16.3	0.39	5.8
090	28.1	0.67	9.9	23.9	0.57	7.1	19.7	0.47	5.1
100	33.9	0.81	14.0	28.3	0.68	10.1	23.7	0.57	7.2
120	37.7	0.90	17.5	31.7	0.76	12.4	26.5	0.63	8.9
140 ⁽¹⁾	42.9	1.03	9.4	35.5	0.85	6.7	14.5	0.35	4.5
160 ⁽¹⁾	52.3	1.25	14.1	44.2	1.06	10.1	18.3	0.44	7.1

Legend

Qhr Total heating capacity reclaimed at the desuperheater(s), kW

q Total water flow rate in the desuperheater loop, l/s

Δp Pressure drop per desuperheater, kPa

(1) Sizes 140 and 160 are fitted with 2 desuperheaters, one per circuit.

Application data

Evaporator entering/leaving water temperature 12/7°C

Outside air temperature 35°C

Desuperheater entering/leaving water temperature difference 10 K

Evaporator fluid: Chilled water

Fouling factor 0.18×10^{-4} (m² K)/W

30RQS 039-160 heating mode

30RQS 039-160	Desuperheater entering water temperature, °C								
	45			50			55		
	Qhr	q	Δp	Qhr	q	Δp	Qc	q	Δp
	kW	l/s	kPa	kW	l/s	kPa	kW	l/s	kPa
039	10.1	0.24	3.8	8.3	0.20	2.7	6.8	0.16	1.8
045	11.1	0.27	4.6	9.3	0.22	3.3	7.7	0.18	2.3
050	14.0	0.33	7.1	11.8	0.28	5.2	9.9	0.24	3.6
060	14.3	0.34	4.4	11.8	0.28	3.0	9.4	0.22	2.0
070	17.1	0.41	6.3	14.4	0.34	4.5	11.9	0.28	3.1
078	19.1	0.46	7.8	16.0	0.38	5.6	13.2	0.32	3.9
080	17.5	0.42	6.6	14.6	0.35	4.8	11.7	0.28	3.2
090	21.4	0.51	6.0	17.7	0.42	4.1	14.7	0.35	2.8
100	20.6	0.49	5.1	16.5	0.39	3.4	12.7	0.30	2.0
120	23.0	0.55	6.9	18.5	0.44	4.7	14.5	0.35	3.0
140 ⁽¹⁾	32.0	0.77	5.5	26.7	0.64	3.8	21.6	0.52	2.6
160 ⁽¹⁾	37.5	0.90	7.3	31.2	0.75	5.4	25.4	0.61	3.7

Legend

Qhr Total heating capacity reclaimed at the desuperheater(s), kW

q Total water flow rate in the desuperheater loop, l/s

Δp Pressure drop per desuperheater, kPa

(1) Sizes 140 and 160 are fitted with 2 desuperheaters, one per circuit.

Application data

Evaporator entering/leaving water temperature 40/45°C

Outside air temperature 7°C

Desuperheater entering/leaving water temperature difference 10 K

Condenser fluid: Water

Fouling factor 0.18×10^{-4} (m² K)/W

HYDRAULIC MODULE (OPTION 116)

This module is equipped with pressure transducers to optimise unit operation at the hydraulic level.

The hydraulic module option reduces the installation time. The unit is factory-equipped with the main hydraulic components required for the system: screen filter, water pump, expansion tank, relief valve and water pressure transducers.

The pressure transducers allow the Touch Pilot Junior control to:

- Display the available pressure at the unit outlet and the static system pressure
- Calculate the instantaneous flow rate, using an algorithm that integrates the unit characteristics
- Integrate the system and water pump protection devices (lack of water, water pressure, water flow rate etc.)

Several water pump types are available: primary single or dual low-pressure pump (RQS only), single or dual high-pressure pump.

An automatic pump start-up algorithm protects the heat exchanger and the hydraulic module piping against frost down to -10°C (30RBS)/ 0°C (30RQS) outside temperature, if the water heat exchanger frost protection option is installed. If necessary increased frost protection down to -20°C is possible by adding heaters to the hydraulic module piping (see option 42).

The hydraulic module option is integrated into the unit without increasing its dimensions and saves the space normally used for the water pump.

Typical hydraulic circuit diagram

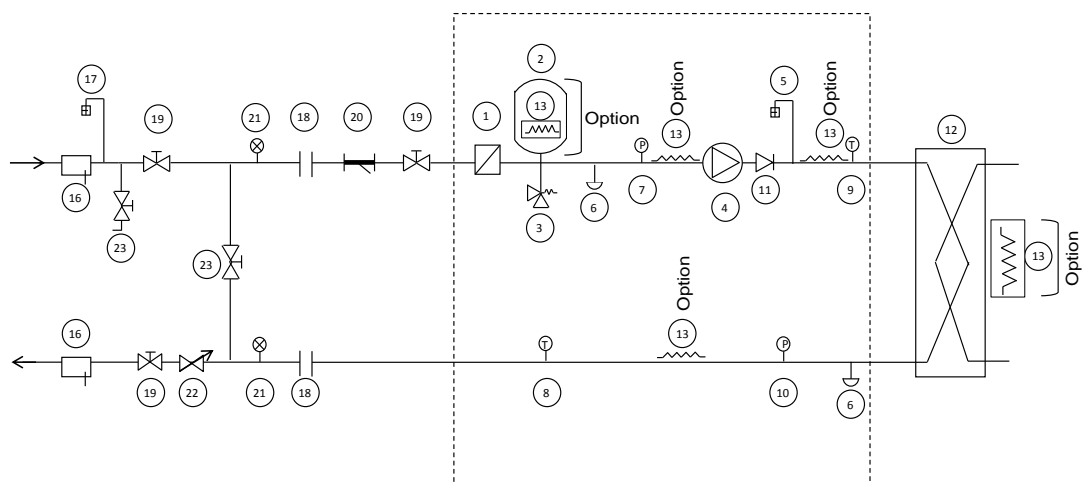

Legend

Components of the unit and hydraulic module

- 1 Screen filter (Mesh 1.2 mm)
- 2 Expansion tank (option)
- 3 Discharge valve
- 4 Available pressure pump (single pump, or dual pump)
- 5 Air purge
- 6 Water drain valve
- 7 Pressure sensor
Note: Gives pump suction pressure information (see regulation manual)
- 8 Temperature probe
Note: Gives heat exchanger leaving temperature information (see regulation manual)
- 9 Temperature probe
Note: Gives heat exchanger entering temperature information (see regulation manual)
- 10 Pressure sensor
Note: Gives heat exchanger leaving pressure information (see regulation manual)
- 11 Check valve (If dual pump)
- 12 Plate heat exchanger
- 13 Heater or tracer for frost protection (Option)
- 14 Flow sensor for water heat exchange

Installation components

- 16 Thermowell
- 17 Air purge
- 18 Flexible connexion
- 19 Shut-off valve
- 20 Screen filter (obligatory for a unit without hydraulic module)
- 21 Pressure gauge
- 22 Water flow control valve
Note: Not necessary for a hydraulic module with a variable-speed pump
- 23 Charge valve
- 24 Frost protection bypass valve (when shut-off valves (19) are closed during winter)
- 25 Buffer tank (if necessary)

--- Hydraulic module (unit with hydraulic module)

Notes:

- The system must be protected against frost.
- The hydraulic module of the unit and the exchanger can be protected (option factory installed) against frost with electric heaters and tracers (13).
- The pressure sensors are installed at connections without Schraeder valves. Depressurise and drain the system before any intervention.

Electrical data, units with hydraulic modules

The pumps that are factory-installed in these units comply with the European Ecodesign directive ErP. The additional electrical data required by regulation 640/2009 is given in the installation, operation and maintenance manual.

This regulation concerns the application of directive 2009/125/EC on the eco-design requirements for electric motors.

VARIABLE WATER FLOW SYSTEM (VWF)

Variable water flow is a hydraulic control function package that permits control of the water flow rate.

The VWF not only ensures control at full load, a specific Carrier algorithm linked to an electronic frequency converter also continuously modulates the flow rate to minimise pump consumption at full load as well as part load.

The hydraulic module includes pressure transducers that permit intelligent measurement of the water flow rate and real-time display on the Touch Pilot Junior interface. All adjustments can be made directly on the interface, speeding up start-up and maintenance.

As VWF acts directly on the pump, the system no longer requires the control valve at the unit outlet. However, for applications with two-way valves a bypass system must be kept to guarantee the minimum flow rate.

Operating logic

■ Full-load set point

The flow rate control at full load uses the Touch Pilot Junior interface, reducing the pump speed. This first control saves energy that would normally be dissipated in the control valve. For example, if the pressure supplied by the pump is reduced by 20% the power consumption of the pump is reduced by the same ratio, compared to a traditional installation.

■ Operating mode at part load

Touch Pilot Junior control includes two part-load operating modes:

- Constant outlet pressure control
- Constant delta T control.

1 – Constant unit outlet pressure control

The control continuously acts on the pump speed to ensure a constant outlet pressure.

This solution is suitable for installations with two-way valves. When these close, the water speed will accelerate in the system branches that are still open. For a fixed-speed pump this results in an unnecessary increase of the pressure at the pump outlet.

The outlet pressure control mode ensures that each circuit branch always has a uniform supply, without unnecessary energy waste.

In industrial processes such as plastic injection moulding, this solution ensures that each terminal unit has the correct pressure supply.

2 – Constant delta T control

The VWF algorithm maintains a constant delta T no matter what the unit load, reducing the flow rate to the minimum.

This solution can be used for systems with two-way or three-way valves and achieves higher energy savings than the “Constant unit outlet pressure control” mode. It is suitable for the majority of comfort applications.

PHYSICAL DATA, 30RBS

30RBS		039	045	050	060	070	080	090	100	120	140	160			
Cooling															
Standard unit Full load performances*	CA1	Nominal capacity	kW		40	44	51	58	67	79	87	97	114	135	156
		EER	kW/kW		2,87	2,76	2,67	2,66	2,72	2,70	2,73	2,73	2,67	2,70	2,65
	Eurovent class				C	C	D	D	C	C	C	C	D	C	D
	CA2	Nominal capacity	kW		53	59	69	81	85	98	114	126	151	171	194
EER		kW/kW		3,44	3,32	3,12	3,31	2,97	3,06	3,18	3,09	3,10	2,99	3,01	
Standard unit Seasonal energy efficiency**	SEER_{12/7°C} Comfort low temp.		kWh/kWh		3,86	3,97	4,03	3,92	3,79	3,85	4,16	4,16	4,07	3,93	4,17
	η_s cool_{12/7°C}		%		152	156	158	154	149	151	164	163	160	154	164
	SEPR_{12/7°C} Process high temp.		kWh/kWh		5,27	5,31	5,26	5,09	4,92	5,16	4,95	5,12	5,51	4,90	5,32
Unit with option 6B Seasonal energy efficiency**	SEPR_{-2/-8°C} Process medium temp.		kWh/kWh		2,88	3,21	2,91	3,09	3,04	2,75	2,97	3,12	3,10	3,07	3,02
Integrated Part Load Value	IPLV.SI	kW/kW		4,540	4,710	4,810	4,580	4,260	4,390	4,550	4,530	4,550	4,290	4,640	
Sound levels															
Standard unit															
Sound power level ⁽¹⁾		dB(A)		80	81	81	81	87	87	84	84	84	90	90	
Sound pressure level at 10 m ⁽²⁾		dB(A)		49	49	49	49	55	55	52	52	52	58	58	
Unit with option 15LS															
Sound power level ⁽¹⁾		dB(A)		79	80	80	80	80	80	83	83	83	83	83	
Sound pressure level at 10 m ⁽²⁾		dB(A)		48	48	48	48	48	48	51	51	51	51	51	
Dimensions															
Length	mm		1061	1061	1061	1061	1061	1061	1061	2258	2258	2258	2258	2258	
Width	mm		2050	2050	2050	2050	2050	2050	2050	2050	2050	2050	2050	2050	
Height	mm		1330	1330	1330	1330	1330	1330	1330	1330	1330	1330	1330	1330	
Operating weight with MCHE coil⁽³⁾															
Standard unit without hydraulic module		kg		429	436	442	454	454	471	766	776	789	896	928	
Standard unit with hydraulic module															
Single high-pressure pump		kg		459	466	472	484	484	501	798	808	825	935	967	
Dual high-pressure pump		kg		484	492	497	510	510	527	843	853	873	972	1004	
Compressors															
Hermetic scroll compressors, 48.3 r/s															
Circuit A				2	2	2	2	2	2	3	3	3	2	2	
Circuit B				-	-	-	-	-	-	-	-	-	2	2	
No of control stages				2	2	2	2	2	2	3	3	3	4	4	
Refrigerant charge with MCHE coil⁽³⁾															
R-410A															
Circuit A		kg		4.7	5.3	5.9	6.7	6.2	7.3	10.7	10.8	11.4	6.5	7.4	
		teqCO ₂		9.8	11.1	12.3	14.0	12.9	15.2	22.3	22.6	23.8	13.6	15.5	
Circuit B		kg		-	-	-	-	-	-	-	-	-	6.5	7.4	
		teqCO ₂		-	-	-	-	-	-	-	-	-	13.6	15.5	

- * In accordance with standard EN14511-3:2013
 ** In accordance with standard EN14825:2016, average climate
- CA1 Cooling mode conditions: Evaporator water entering/leaving temperature 12°C/7°C, outside air temperature 35°C, evaporator fooling factor 0 m².K/W
- CA2 Cooling mode conditions: Evaporator water entering/leaving temperature 23°C/18°C, outside air temperature 35°C, evaporator fooling factor 0 m².K/W
- η_s cool_{12/7°C} & SEER_{12/7°C} **Bold values compliant to Ecodesign regulation: (EU) No 2016/2281 for Comfort application**
 SEPR_{12/7°C} **Bold values compliant to Ecodesign regulation: (EU) No 2016/2281 for Process application**
 SEPR_{-2/-8°C} **Bold values compliant to Ecodesign regulation: (EU) No 2015/1095 for Process application**
 IPLV.SI Calculations according to standard performances AHRI 551-591 (SI).
- (1) In dB ref=10⁻¹² W, (A) weighting. Declared dualnumber noise emission values in accordance with ISO 4871 (with an associated uncertainty of +/-3dB(A)). Measured in accordance with ISO 9614-1 and certified by Eurovent.
- (2) In dB ref 20μPa, (A) weighting. Declared dualnumber noise emission values in accordance with ISO 4871 (with an associated uncertainty of +/-3dB(A)). For information, calculated from the sound power level Lw(A).
- (3) Values shown are a guideline only. Please refer to the unit nameplate



Eurovent certified values

PHYSICAL DATA, 30RBS

30RBS	039	045	050	060	070	080	090	100	120	140	160	
Capacity control	Touch Pilot Junior											
Minimum capacity	%	50	50	50	50	50	50	33	33	33	25	25
Condensers	All-aluminium microchannel heat exchanger (MCHE)											
Fans	Axial Flying Bird IV with rotating shroud											
Quantity		1	1	1	1	1	1	2	2	2	2	2
Maximum total air flow	l/s	3885	3883	3687	3908	5013	5278	6940	6936	7370	10026	10556
Maximum rotation speed	r/s	12	12	12	12	16	16	12	12	12	16	16
Evaporator	Direct expansion, plate heat exchanger											
Water volume	l	2.6	3.0	3.3	4.0	4.8	5.6	8.7	9.9	11.3	12.4	14.7
Without hydraulic module (option)												
Max. water-side operating pressure	kPa	1000	1000	1000	1000	1000	1000	1000	1000	1000	1000	1000
With hydraulic module (option)												
Single or dual pump (as selected)	Pump, Victaulic screen filter, relief valve, expansion tank, purge valves (water + air), pressure sensors											
Expansion tank volume	l	12	12	12	12	12	12	35	35	35	35	35
Expansion tank pressure ⁽⁴⁾	bar	1	1	1	1	1	1	1.5	1.5	1.5	1.5	1.5
Max. water-side operating pressure	kPa	400	400	400	400	400	400	400	400	400	400	400
Water connections with/without hydraulic module	Victaulic											
Diameter	in	2	2	2	2	2	2	2	2	2	2	2
Outside tube diameter	mm	60.3	60.3	60.3	60.3	60.3	60.3	60.3	60.3	60.3	60.3	60.3
Chassis paint colour	Colour code: RAL7035											

- (4) When delivered, the standard pre-inflation of the tank is not necessarily the optimal value for the system. To permit changing the water volume, change the inflation pressure to a pressure that is close to the static head of the system. Fill the system with water (purging the air) to a pressure value that is 10 to 20 kPa higher than the pressure in the tank.

PHYSICAL DATA, 30RQS

30RQS			39	45	50	60	70	78	80	90	100	120	140	160	
Heating															
Standard unit Full load performances*	HA1	Nominal capacity	kW	42,3	46,4	53,2	61,2	68,0	77,6	81,7	92,2	100	116	135	155
		COP	kW/kW	3,69	3,69	3,76	3,72	3,64	3,46	3,78	3,80	3,76	3,68	3,61	3,47
	HA2	Nominal capacity	kW	41,5	46,3	51,7	59,3	65,9	75,0	78,9	89,5	97,4	112	130	150
		COP	kW/kW	3,05	3,02	3,01	3,01	2,98	2,85	3,11	3,05	3,06	3,00	2,94	2,86
Standard unit Seasonal efficiency**	HA1	SCOP _{30/35°C}	kWh/kWh	3,32	3,39	3,53	3,40	3,40	3,28	3,51	3,50	3,57	3,54	3,44	3,42
		η_s heat _{30/35°C}	%	130	133	138	133	133	128	137	137	140	139	135	134
		P _{rated}	kW	35,5	31,6	36,3	43,8	50,1	55,7	56,8	81,5	72,3	84,2	99,4	111
		Energy labelling		A+	A+	A+	A+	A+	A+	A+	-	-	-	-	-
Cooling															
Standard unit Full load performances*	CA1	Nominal capacity	kW	37,7	43,1	49,4	58,0	63,1	70,2	77,0	84,9	95,1	112	131	148
		EER	kW/kW	2,80	2,66	2,61	2,72	2,66	2,43	2,75	2,66	2,66	2,65	2,73	2,54
		Eurovent class		C	D	D	C	D	E	C	D	D	D	C	D
	CA2	Nominal capacity	kW	47,1	53,9	62,7	70,7	78,2	88,5	96,5	107	117	142	162	185
EER		kW/kW	3,23	3,11	3,04	3,08	3,04	2,81	3,14	3,09	3,05	3,05	3,12	2,88	
Standard unit Seasonal energy efficiency**		SEER _{12/7°C} Comfort low temp.	kWh/kWh	3,64	3,67	3,70	3,53	3,49	3,37	3,83	3,70	3,76	4,00	3,65	3,62
		SEPR _{12/7°C} Process high temp.	kWh/kWh	4,92	4,95	4,74	4,53	4,44	4,72	5,16	4,67	4,62	5,15	4,59	4,95
Unit with option 6B Seasonal energy efficiency**		SEPR _{-2/-8°C} Process medium temp.	kWh/kWh	2,58	2,58	2,61	2,96	2,98	2,86	2,70	2,86	3,04	2,94	2,80	2,68
Integrated Part Load Value		IPLV.SI	kW/kW	4,464	4,447	4,409	4,127	4,102	4,033	4,475	4,314	4,378	4,795	4,246	4,295
Sound levels															
Standard unit															
Sound power level ⁽¹⁾		dB(A)	80	81	81	86	87	87	84	84	84	84	90	90	
Sound pressure level at 10 m ⁽²⁾		dB(A)	49	49	49	55	55	55	52	52	52	52	58	58	
Unit with option 15LS															
Sound power level ⁽¹⁾		dB(A)	79	80	80	80	80	80	83	83	83	83	83	83	
Sound pressure level at 10 m ⁽²⁾		dB(A)	48	48	48	48	48	48	51	51	51	51	51	51	
Dimensions															
Length		mm	1090	1090	1090	1090	1090	1090	2273	2273	2273	2273	2273	2273	
Width		mm	2109	2109	2109	2109	2109	2109	2136	2136	2136	2136	2136	2136	
Height		mm	1330	1330	1330	1330	1330	1330	1330	1330	1330	1330	1330	1330	
Operating weight⁽³⁾															
Standard unit without hydraulic module		kg	497	504	533	546	547	554	739	886	894	953	1054	1072	
Standard unit with hydraulic module															
Single high-pressure pump		kg	529	537	563	576	576	584	769	918	926	989	1093	1111	
Dual high-pressure pump		kg	555	563	588	602	602	610	795	963	971	1037	1130	1148	

- * In accordance with standard EN14511-3:2013
** In accordance with standard EN14825:2016, average climate
- HA1 Heating mode conditions: Water heat exchanger water entering/leaving temperature 30°C/35°C, outside air temperature tdb/twb = 7°C db/6°C wb, evaporator fooling factor 0 m².K/W
- HA2 Heating mode conditions: Water heat exchanger water entering/leaving temperature 40°C/45°C, outside air temperature tdb/twb = 7°C db/6°C wb, evaporator fooling factor 0 m².K/W
- CA1 Cooling mode conditions: Evaporator water entering/leaving temperature 12°C/7°C, outside air temperature 35°C, evaporator fooling factor 0 m².K/W
- CA2 Cooling mode conditions: Evaporator water entering/leaving temperature 23°C/18°C, outside air temperature 35°C, evaporator fooling factor 0 m².K/W
- η_s heat _{30/35°C} & SCOP _{30/35°C} **Bold values compliant to Ecodesign regulation: (EU) No 813/2013 for Heat Pump application**
SEER _{12/7°C} & SEPR _{12/7°C} Values calculated in accordance with EN14825:2016
SEPR _{-2/-8°C} Values calculated in accordance with EN14825:2016
IPLV.SI Calculations according to standard performances AHRI 551-591 (SI).
- Not applicable
- (1) In dB ref=10-12 W, (A) weighting. Declared dualnumber noise emission values in accordance with ISO 4871 (with an associated uncertainty of +/-3dB(A)). Measured in accordance with ISO 9614-1 and certified by Eurovent.
(2) In dB ref 20µPa, (A) weighting. Declared dualnumber noise emission values in accordance with ISO 4871 (with an associated uncertainty of +/-3dB(A)). For information, calculated from the sound power level Lw(A).
(3) Values shown are a guideline only. Please refer to the unit nameplate



Eurovent certified values

PHYSICAL DATA, 30RQS

30RQS		39	45	50	60	70	78	80	90	100	120	140	160
Compressors		Hermetic scroll compressors, 48.3 r/s											
Circuit A		2	2	2	2	2	2	2	3	3	3	2	2
Circuit B		-	-	-	-	-	-	-	-	-	-	2	2
No of control stages		2	2	2	2	2	2	2	3	3	3	4	4
Refrigerant charge⁽³⁾		R-410A											
Circuit A	kg	12.5	13.5	16.5	17.5	18	16.5	21.5	27.5	28.5	33	19	18.5
	teqCO ₂	26.1	28.2	34.5	36.5	37.6	34.5	44.9	57.4	59.5	68.9	39.7	38.6
Circuit B	kg	-	-	-	-	-	-	-	-	-	-	19	18.5
	teqCO ₂	-	-	-	-	-	-	-	-	-	-	39.7	38.6
Capacity control		Touch Pilot Junior											
Minimum capacity	%	50	50	50	50	50	50	50	33	33	33	25	25
Air heat exchangers		Grooved copper tubes and aluminium fins											
Fans		Axial Flying Bird IV with rotating shroud											
Quantity		1	1	1	1	1	1	2	2	2	2	2	2
Maximum total air flow	l/s	3692	3690	3910	5285	5284	5282	7770	7380	7376	7818	10568	10568
Maximum rotation speed	r/s	12	12	12	16	16	16	12	12	12	12	16	16
Water heat exchanger		Direct expansion. plate heat exchanger											
Water volume	l	2.6	3	4	4.8	4.8	5.6	8.7	8.7	9.9	11.3	12.4	14.7
Without hydraulic module													
Max. water-side operating pressure	kPa	1000	1000	1000	1000	1000	1000	1000	1000	1000	1000	1000	1000
With hydraulic module (option)		Pump, Victaulic screen filter, relief valve, expansion tank, purge valves (water + air), pressure sensors											
Single or dual pump (as selected)													
Expansion tank volume	l	12	12	12	12	12	12	35	35	35	35	35	35
Expansion tank pressure ⁽⁴⁾	bar	1	1	1	1	1	1	1	1.5	1.5	1.5	1.5	1.5
Max. water-side operating pressure	kPa	400	400	400	400	400	400	400	400	400	400	400	400
Water connections with/without hydraulic module		Victaulic											
Connections	in	2	2	2	2	2	2	2	2	2	2	2	2
Outside diameter	mm	60.3	60.3	60.3	60.3	60.3	60.3	60.3	60.3	60.3	60.3	60.3	60.3
Chassis paint colour		Colour code: RAL7035											

(3) Values shown are a guideline only. Please refer to the unit nameplate

(4) When delivered, the standard pre-inflation of the tank is not necessarily the optimal value for the system. To permit changing the water volume, change the inflation pressure to a pressure that is close to the static head of the system. Fill the system with water (purging the air) to a pressure value that is 10 to 20 kPa higher than the pressure in the tank

ELECTRICAL DATA, 30RBS

30RBS without hydraulic module	039	045	050	060	070	080	090	100	120	140	160	
Power circuit												
Nominal power supply	V-ph-Hz	400-3-50										
Voltage range	V	360-440										
Control circuit supply												
24 V via internal transformer												
Maximum start-up current (Un)⁽¹⁾												
Standard unit	A	114	135	143	146	176	213	174	208	248	243	286
Unit with electronic starter option	A	75	87	94	96	114	140	125	150	176	186	215
Unit power factor at maximum capacity⁽²⁾		0.83	0.81	0.81	0.83	0.81	0.78	0.83	0.81	0.79	0.81	0.78
Maximum operating power input⁽²⁾	kW	20	22	25	28	31	36	42	46	53	62	72
Nominal unit operating current draw⁽³⁾	A	26	29	33	36	42	53	55	62	77	85	106
Maximum operating current draw (Un)⁽⁴⁾	A	35	45	47	53	67	73	81	99	108	134	146
Maximum operating current draw (Un-10%)[†]	A	38	49	51	58	75	80	89	110	118	150	159
Customer-side unit power reserve	Customer reserve at the 24 V control power circuit											
Short-circuit stability and protection	See table 9.1											

(1) Maximum instantaneous start-up current at operating limit value (maximum operating current of the smallest compressor(s) + fan current + locked rotor current of the largest compressor).

(2) Power input, at the unit permanent maximum operating conditions (data given on the unit nameplate)

(3) Standardised Eurovent conditions: evaporator entering/leaving water temperature 12°C/7°C, outside air temperature 35°C.

(4) Maximum unit current at 400 V, non permanent operating conditions (values given on the unit nameplate).

† Maximum unit operating current at 360 V, non permanent operating conditions.

Short-circuit stability current (TN system⁽¹⁾)

30RBS	039	045	050	060	070	080
Value without upstream protection						
Short-term current at 1s - I _{cw} - kA rms	3.36	3.36	3.36	3.36	3.36	3.36
Admissible peak current - I _{pk} - kA pk	20	20	20	20	20	15
Value with upstream protection by circuit breaker						
Conditional short-circuit current I _{cc} - kA rms	40	40	40	40	40	40
Schneider circuit breaker - Compact series	NS100H	NS100H	NS100H	NS100H	NS100H	NS100H
Reference No. ⁽²⁾	29670	29670	29670	29670	29670	29670

30RBS	090	100	120	140	160
Value without upstream protection					
Short-term current at 1s - I _{cw} - kA rms	5.62	5.62	5.62	5.62	5.62
Admissible peak current - I _{pk} - kA pk	20	20	15	20	15
Value with upstream protection by circuit breaker					
Conditional short-circuit current I _{cc} - kA rms	40	40	40	30	30
Schneider circuit breaker - Compact series	NS100H	NS160H	NS160H	NS250H	NS250H
Reference No. ⁽²⁾	29670	30670	30670	31671	31671

(1) Earthing system type

(2) If another current limitation protection system is used, its time-current and thermal constraint (I²t) trip characteristics must be at least equivalent to those of the recommended Schneider circuit breaker.

The short-circuit stability current values above are suitable with the TN system.

ELECTRICAL DATA, 30RQS

Electrical data, 30RQS

30RQS without hydraulic module		039	045	050	060	070	078	080	090	100	120	140	160
Power circuit													
Nominal power supply	V-ph-Hz	400-3-50											
Voltage range	V	360-440											
Control circuit supply		24 V via internal transformer											
Maximum start-up current (Un)⁽¹⁾													
Standard unit	A	114	135	143	146	176	213	214	174	208	248	243	286
Unit with electronic starter option	A	75	87	94	96	114	140	140	125	150	176	186	215
Unit power factor at maximum capacity⁽²⁾		0.83	0.81	0.81	0.83	0.81	0.78	0.78	0.83	0.81	0.79	0.81	0.78
Maximum operating power input⁽²⁾	kW	20	22	25	28	31	36	36	42	46	53	62	72
Nominal unit operating current draw⁽³⁾	A	26	29	33	36	42	53	53	55	62	77	85	106
Maximum operating current draw (Un)⁽⁴⁾	A	35	45	47	53	67	73	74	81	99	108	134	146
Maximum operating current draw (Un-10%)[†]	A	38	49	51	58	75	80	80	89	110	118	150	159
Customer-side unit power reserve		Customer reserve at the 24 V control power circuit											
Short-circuit stability and protection		See table 9.1											

- (1) Maximum instantaneous start-up current at operating limit value (maximum operating current of the smallest compressor(s) + fan current + locked rotor current of the largest compressor).
- (2) Power input, at the unit permanent maximum operating conditions (data given on the unit nameplate)
- (3) Standardised Eurovent conditions: evaporator entering/leaving water temperature 12°C/7°C, outside air temperature 35°C.
- (4) Maximum unit current at 400 V, non permanent operating conditions (values given on the unit nameplate).
- † Maximum unit operating current at 360 V, non permanent operating conditions.

Short-circuit stability current (TN system⁽¹⁾)

30RQS	039	045	050	060	070	078
Value without upstream protection						
Short-term current at 1s - I _{cs} - kA rms	3.36	3.36	3.36	3.36	3.36	3.36
Admissible peak current - I _{pk} - kA pk	20	20	20	20	20	15
Value with upstream protection by circuit breaker						
Conditional short-circuit current I _{cc} - kA rms	40	40	40	40	40	40
Schneider circuit breaker - Compact series	NS100H	NS100H	NS100H	NS100H	NS100H	NS100H
Reference No. ⁽²⁾	29670	29670	29670	29670	29670	29670

30RQS	080	090	100	120	140	160
Value without upstream protection						
Short-term current at 1s - I _{cs} - kA rms	3.36	5.62	5.62	5.62	5.62	5.62
Admissible peak current - I _{pk} - kA pk	15	20	20	15	20	15
Value with upstream protection by circuit breaker						
Conditional short-circuit current I _{cc} - kA rms	40	40	40	40	30	30
Schneider circuit breaker - Compact series	NS100H	NS100H	NS160H	NS160H	NS250H	NS250H
Reference No. ⁽²⁾	29670	29670	30670	30670	31671	31671

- (1) Earthing system type
- (2) If another current limitation protection system is used, its time-current and thermal constraint (I²t) trip characteristics must be at least equivalent to those of the recommended Schneider circuit breaker.
The short-circuit stability current values above are suitable with the TN system.

ELECTRICAL DATA

Electrical data and operating conditions notes:

- 30RB/RQ 039-160 units have a single power connection point located immediately upstream of the field power connections.
- The control box includes the following standard features:
 - starter and motor protection devices for each compressor, the fans and the pump,
 - the control devices.
 - A main disconnect switch can be installed within the box with the option 70.
- Field connections:
All connections to the system and the electrical installations must be in full accordance with all applicable local codes.
- The Carrier 30RB/RQ units are designed and built to ensure conformance with these codes. The recommendations of European standard EN 60204-1 (machine safety - electrical machine components - part 1: general regulations - corresponds to IEC 60204-1) are specifically taken into account, when designing the electrical equipment*.
- An auxiliary contactor is available with the QF breaker allowing a safety channel installation to ensure a feedback output about heater and board power supply status and then prevent evaporator from frosting when heaters and boards are off.

NOTES:

- Generally the recommendations of IEC 60364 are accepted as compliance with the requirements of the installation directives. Conformance with EN 60204-1 is the best means of ensuring compliance with the Machines Directive § 1.5.1.
- Annex B of EN 60204-1 describes the electrical characteristics used for the operation of the machines.

- The operating environment for the 30RB/RQ units is specified below:
 1. Environment** - Environment as classified in EN 60721 (corresponds to IEC 60721):
 - outdoor installation**
 - ambient temperature range: -20°C to +48°C, class 4K4H
 - altitude: ≤ 2000 m (for hydraulic kit see chapter 9.2 of the installation manual
 - presence of hard solids, class 4S2 (no significant dust present)
 - presence of corrosive and polluting substances, class 4C2 (negligible)
 2. Power supply frequency variation: ± 2 Hz.
 3. The neutral (N) conductor must not be connected directly to the unit (if necessary use a transformer).
 4. Overcurrent protection of the power supply conductors is not provided with the unit.
 5. The factory-installed disconnect switch (option 70) is of a type suitable for power interruption in accordance with EN 60947.
 6. The units are designed for connection to TN(S) networks (IEC 60364). For IT networks the earth connection must not be at the network earth. Provide a local earth, consult competent local organisations to complete the electrical installation. Units delivered with speed drive (options 28 and 116J/K/V/W) are not compatible with IT network.

Caution: If particular aspects of an actual installation do not conform to the conditions described above, or if there are other conditions which should be considered, always contact your local Carrier representative.

* The absence of main power disconnect switch on standard machines is an exception that must be taken in account at field installation level.

**The required protection level for this class is IP43BW (according to reference document IEC 60529). All 30RB/RQ units fulfil this protection condition.

- Closed electrical box is IP44CW
- Open electrical box (when accessing to interface) is IPxxB

PART LOAD PERFORMANCES

With the rapid increase in energy costs and the care about environmental impacts of electricity production, the power consumption of air conditioning equipment has become an important topic. The energy efficiency of a unit at full load is rarely representative of the actual performance of the units, as on average a unit works less than 5% of the time at full load.

IPLV (in accordance with AHRI 550/590)

The IPLV (integrated part load value) allows evaluation of the average energy efficiency based on four operating conditions defined by the AHRI (Air Conditioning, Heating and Refrigeration Institute). The IPLV is the average weighted value of the cooling coefficient of performance (COPr) at different operating conditions, weighted by the operating time.

IPLV (integrated part load value)

Load %	Air temperature °C	Energy efficiency	Operating time %
100	35	COPr ₁	1
75	26.7	COPr ₂	42
50	18.3	COPr ₃	45
25	12.8	COPr ₄	12

$$\text{IPLV} = \text{COPr}_1 \times 1\% + \text{COPr}_2 \times 42\% + \text{COPr}_3 \times 45\% + \text{COPr}_4 \times 12\%$$

Note: Constant leaving water temperature 6.67°C.

SCOP (In accordance with EU ECODESIGN)

The SCOP (Seasonal Coefficient of Performance) permit evaluation of the average energy efficiency at part load, based on multipoint conditions (16°C to -10°C for average climate) and number of hours occurring at each air temperature (Bin hours).

To be able to compare the energy efficiency of boilers using a primary energy source (gas or fuel) with heat pumps using a final energy source (electricity), the seasonal efficiency criteria used by the Ecodesign regulations is known as ηs it is based on the use of primary energy sources and expressed in % (Ecodesign regulation 813/2013).

The heat load of a building depends on many factors, such as the outside air temperature, the exposure to the sun and the building occupancy.

Consequently it is preferable to use the average energy efficiency, calculated at several operating points that are representative for the unit utilisation.

SEER for comfort chillers (in accordance with EU ECODESIGN)

The SEER (Seasonal Energy Efficiency Ratio) measures the seasonal energy efficiency of comfort chillers by calculating the ratio between annual cooling demand of the building and annual energy demand of the chiller. It takes into account the energy efficiency achieved for each outdoor temperature weighted by the number of hours observed for each of these temperatures, using actual climate data.

SEER is a new way of measuring the true energy efficiency of chillers for comfort cooling over an entire year.

This new indicator gives a more realistic indication of the real energy efficiency and environmental impact of a cooling system (Ecodesign Regulation 2016/2281).

SEPR for process chillers (in accordance with EU ECODESIGN)

The SEPR (Seasonal Energy Performance Ratio) measures the seasonal energy efficiency of process chillers by calculating the ratio between annual cooling demand of the process and annual energy demand of the chiller. It takes into account the energy efficiency achieved at each outdoor temperature of an average climate weighted by the number of hours observed for each of these temperatures.

SEPR is a new way of measuring the true energy efficiency of chillers for process cooling over an entire year. This new indicator gives a more realistic indication of the real energy efficiency and environmental impact of the cooling system (Ecodesign Regulation 2015/1095 or 2016/2281).

OPERATING LIMITS, 30RBS

Evaporator water flow rate

30RBS	Flow rate, l/s		
	Minimum	Maximum ⁽¹⁾	Maximum dual pump ⁽²⁾ High pressure ⁽³⁾
039	0.9	3	3.4
045	0.9	3.4	3.8
050	0.9	3.7	4
060	0.9	4.2	4.4
070	1	5	5
080	1.2	5.5	5.2
090	1.3	6.8	6.2
100	1.5	7.7	6.5
120	1.7	8.5	8
140	2	10.6	8.7
160	2.3	11.2	8.9

- (1) Maximum flow rate at a pressure drop of 100 kPa in the plate heat exchanger (unit without hydraulic module).
- (2) Maximum flow rate at an available pressure of 50 kPa (high-pressure module).
- (3) Maximum flow rate with single pump is 2 to 4% higher, depending on the size.

Operating range

30RBS	Minimum	Maximum
Evaporator		
Entering water temperature at start-up	°C	7.5 ⁽¹⁾ 30
Leaving water temperature during operation	°C	5 ⁽²⁾ 20
Entering/leaving water temperature difference	K	3 10
Condenser		
Entering air temperature, full load ⁽³⁾	°C	-10 46
Entering air temperature, part load ⁽³⁾	°C	-10 48
Hydraulic module⁽⁴⁾		
Entering air temperature		
Kit without pump	°C	-20 -
Kit with pump (option 116x)	°C	-10 -
Kit with pump (option 116x) and frost protection option to -20°C (option 42)	°C	-20 -

Note: Do not exceed the maximum operating temperature.

- (1) For entering water temperatures below 7.5°C at start-up, contact Carrier.
- (2) For low-temperature applications, where the leaving water temperature is below 5°C, a frost protection solution must be used.
- (3) Ambient temperature: Please refer to option 20 for low-temperature applications (< -10°C). For transport and storage of the 30RBS units the minimum and maximum allowable temperatures are -20°C and +48°C. It is recommended that these temperatures are used for transport by container.
- (4) Defines the frost-free temperature of the hydraulic components for use without glycol.

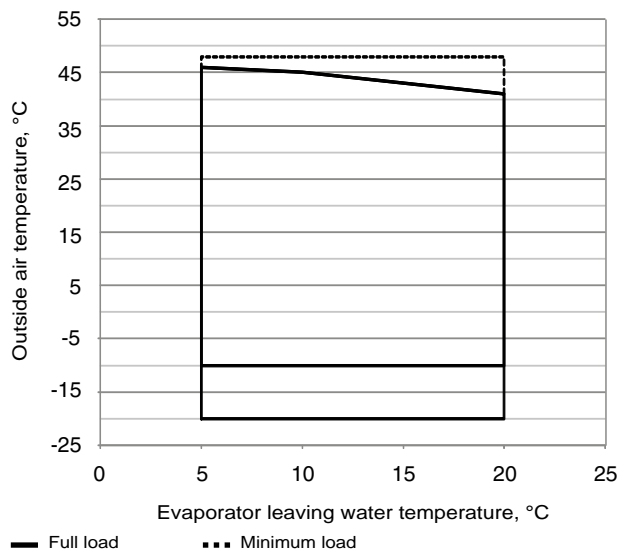

NOTE: This operating range applies up to 130 Pa static pressure without suction air duct for sizes 070 and 080 and 140-160, and up to 240 Pa for all other sizes.

OPERATING LIMITS, 30RQS

Water heat exchanger water flow rate

30RQS	Flow rate, l/s			
	Minimum	Maximum ⁽¹⁾	Maximum dual pump ⁽²⁾	
			Low pressure ⁽³⁾	High pressure ⁽³⁾
039	0.9	3	2.9	3.4
045	0.9	3.4	3.2	3.8
050	0.9	4.2	3.7	4.4
060	0.9	5	4.1	5
070	1	5	4.1	5
078	1.2	5.5	4.4	5.2
080	1.2	6.8	5.1	6.2
090	1.3	6.8	5.1	6.2
100	1.5	7.7	6.3	6.5
120	1.7	8.5	6.5	8
140	2	10.6	7.9	8.7
160	2.3	11.2	8.2	8.9

- (1) Maximum flow rate at a pressure drop of 100 kPa in the plate heat exchanger (unit without hydraulic module).
- (2) Maximum flow rate at an available pressure of 20 kPa (unit with low-pressure hydraulic module) or 50 kPa (high-pressure module).
- (3) Maximum flow rate with single pump is 2 to 4% higher, depending on the size.

Operating range, standard unit, cooling mode

30RQS	Minimum	Maximum
Evaporator		
Entering water temperature at start-up °C	7,5	30
Leaving water temperature during operation °C	5 ⁽¹⁾	20
Entering/leaving water temperature difference K	3	10
Condenser		
Entering air temperature ⁽²⁾ °C	-10	48
Hydraulic module⁽³⁾		
Entering air temperature		
Kit without pump °C	-20	-
Kit with pump (option 116x) °C	0	-
Kit with pump (option 116x) and frost protection option to -20°C (option 42) °C	-20	-

- Note:** Do not exceed the maximum operating temperature.
- (1) If the leaving water temperature is below 5°C, a frost protection solution must be used.
 - (2) For transport and storage of the 30RQS units the minimum and maximum allowable temperatures are -20°C and +48°C. It is recommended that these temperatures are used for transport by container.
 - (3) Defines the frost-free temperature of the hydraulic components for use without glycol.

30RQS (cooling mode)

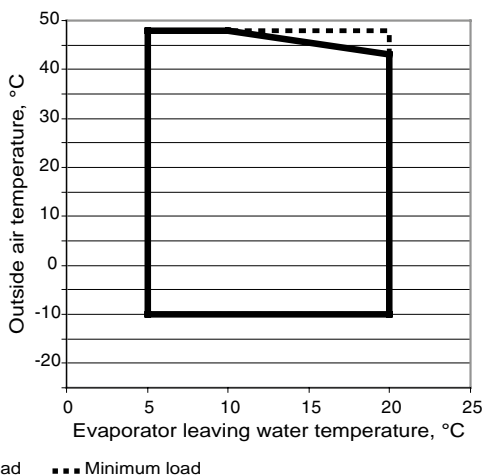

Operating range, standard unit, heating mode

30RQS	Minimum	Maximum
Condenser		
Entering water temperature at start-up °C	8	45
Leaving water temperature during operation °C	25	55
Entering/leaving water temperature difference K	3	10
Evaporator		
Air temperature °C	-15	40
Hydraulic module⁽¹⁾		
Entering air temperature		
Kit without pump °C	-20	-
Kit with pump (option 116x) °C	0	-
Kit with pump (option 116x) and frost protection option to -20°C (option 42) °C	-20	-

- Note:** Do not exceed the maximum operating temperature.
- (1) Defines the frost-free temperature of the hydraulic components for use without glycol.

30RQS (heating mode)

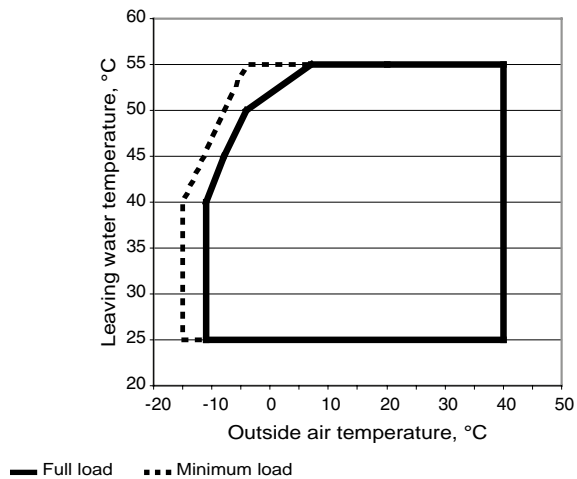

AVAILABLE EXTERNAL STATIC PRESSURE, 30RBS

Data applicable for:

- Fresh water 20 °C
- In case of use of glycol, the maximum water flow is reduced.

High-pressure pump

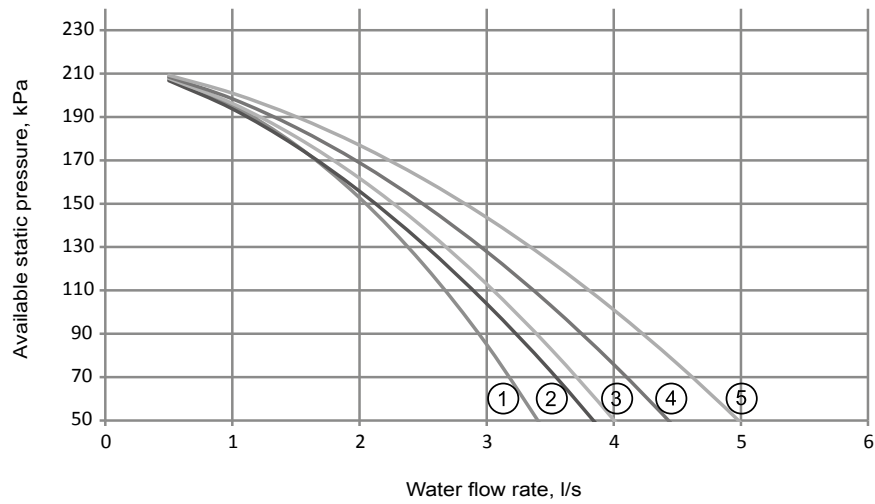

Legend

1. 30RBS 039
2. 30RBS 045
3. 30RBS 050
4. 30RBS 060
5. 30RBS 070
6. 30RBS 080

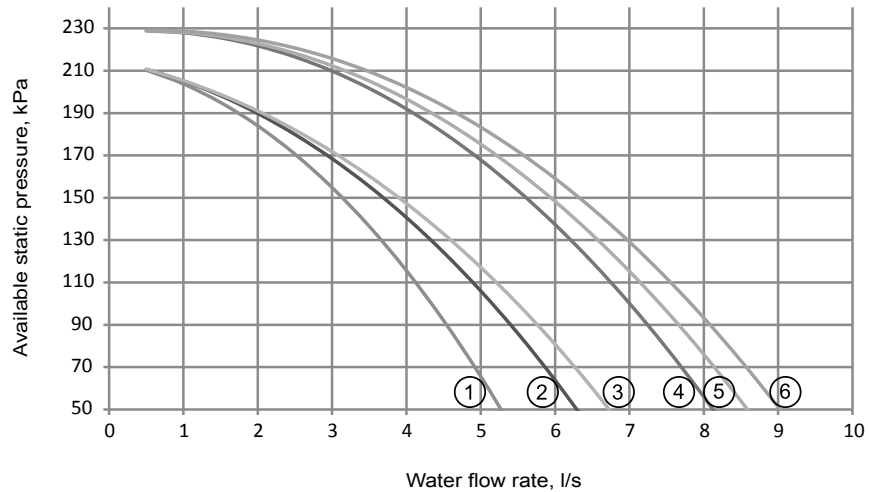

Legend

1. 30RBS 090
2. 30RBS 100
3. 30RBS 120
4. 30RBS 140
5. 30RBS 160

AVAILABLE EXTERNAL STATIC PRESSURE, 30RQS

Data applicable for:

- Fresh water 20 °C
- In case of use of glycol, the maximum water flow is reduced.

Low-pressure pump

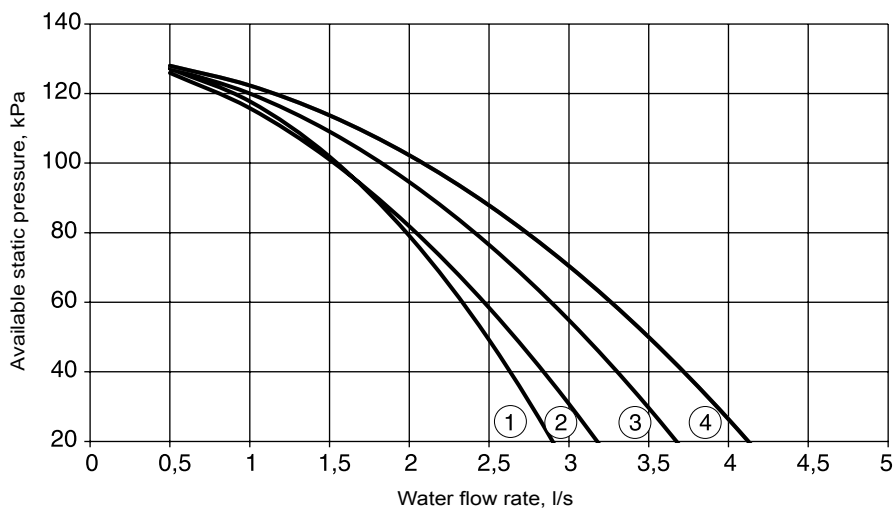

Legend

1. 30RQS 039
2. 30RQS 045
3. 30RQS 050
4. 30RQS 060 & 070

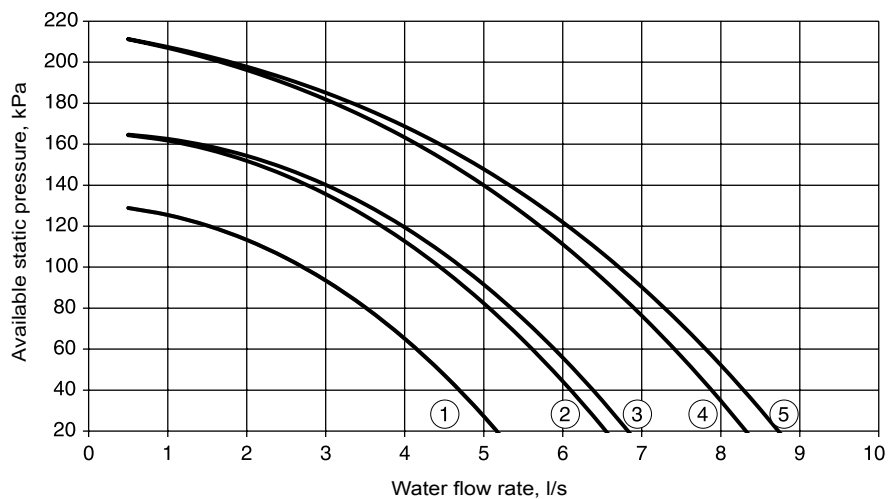

Legend

1. 30RQS 080 & 090
2. 30RQS 100
3. 30RQS 120
4. 30RQS 140
5. 30RQSY 160

AVAILABLE EXTERNAL STATIC PRESSURE, 30RQS

Data applicable for:

- Fresh water 20 °C
- In case of use of glycol, the maximum water flow is reduced.

High-pressure pump

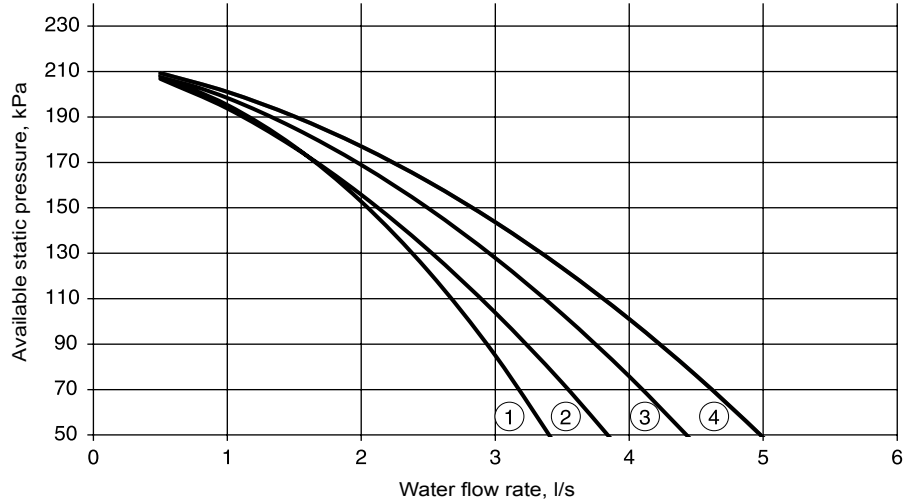

Legend

1. 30RQS 039
2. 30RQS 045
3. 30RQS 050
4. 30RQS 060 & 070

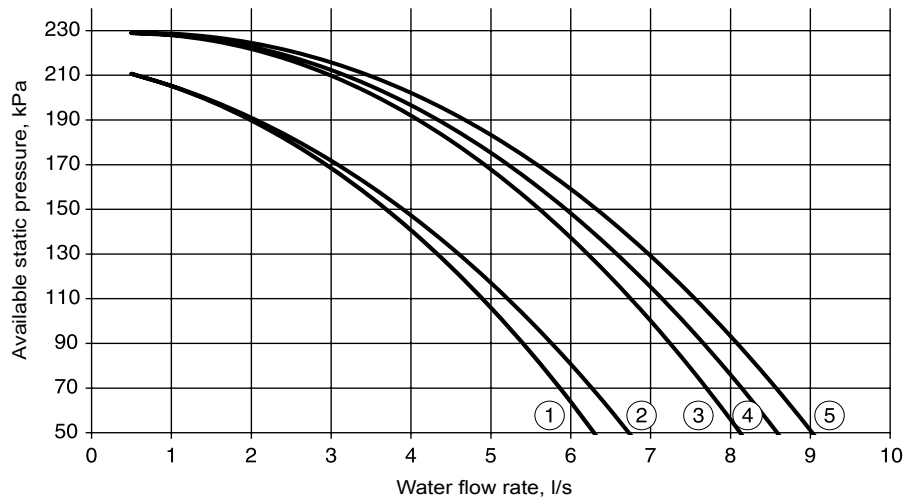

Legend

1. 30RQS 080 & 090
2. 30RQS 100
3. 30RQS 120
4. 30RQS 140
5. 30RQS 160



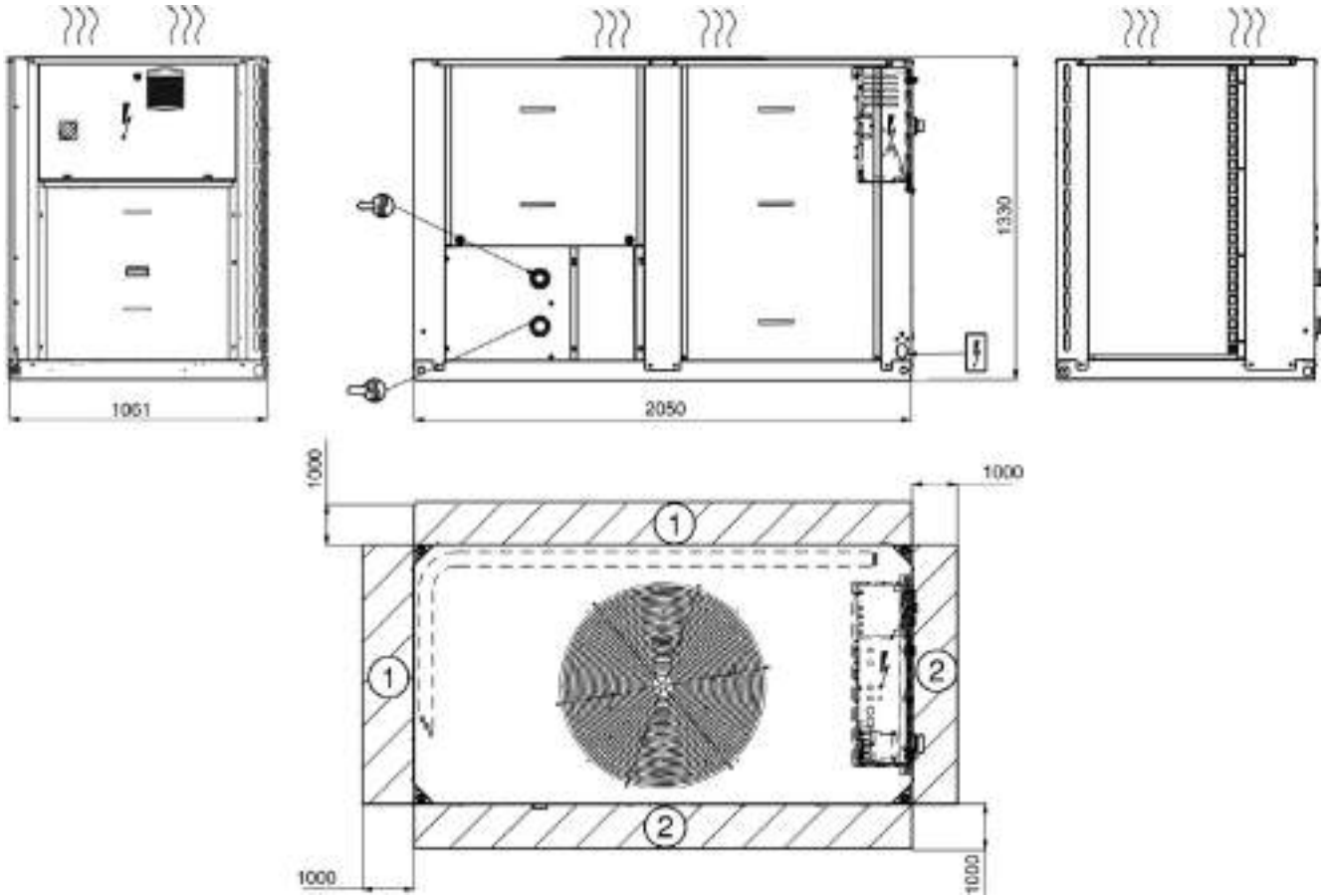

DIMENSIONS/CLEARANCES, 30RBS

30RBS 039-080, units with and without hydraulic module



Legend:

All dimensions are given in mm

-  Control box
-  Water inlet
-  Water outlet
- ① Required clearances for air entry
- ② Recommended space for maintenance
-  Air outlet, do not obstruct
-  Power supply inlet

NOTES:

- A Non-certified drawings.**
Refer to the certified dimensional drawings supplied with the unit or available on request, when designing an installation.
For the location of fixing points, weight distribution and coordinates of the centre of gravity refer to the certified dimensional drawings.
- B In multiple-chiller installations (maximum four units),** the side clearance between the units should be increased from 1000 to 2000 mm.
- C The height of the solid surface must not exceed 2 m.**



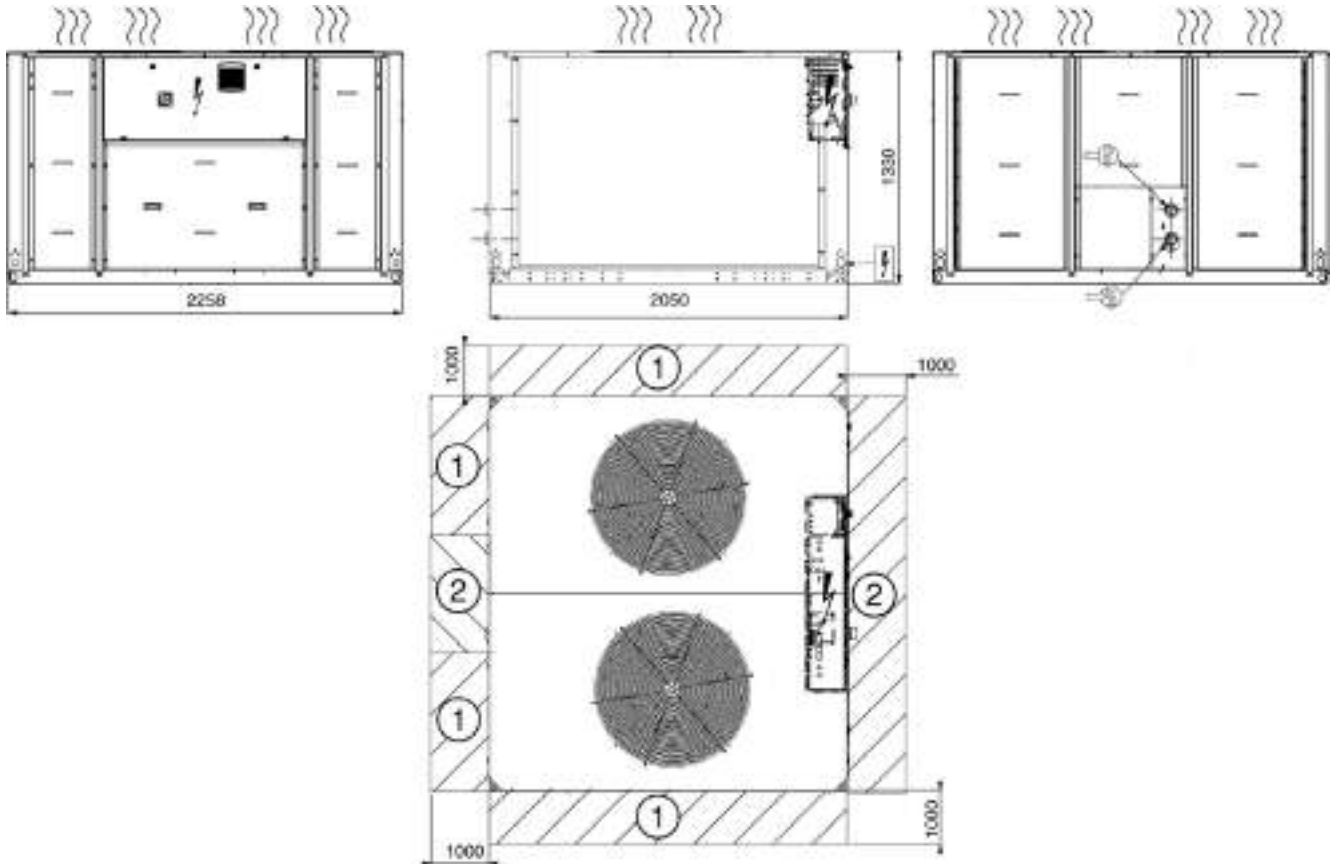

DIMENSIONS/CLEARANCES, 30RBS

30RBS 090-160, units with and without hydraulic module



Legend:

All dimensions are given in mm

-  Control box
-  Water inlet
-  Water outlet
- ① Required clearances for air entry
- ② Recommended space for maintenance
-  Air outlet, do not obstruct
-  Power supply inlet

NOTES:

- A Non-certified drawings.**
Refer to the certified dimensional drawings supplied with the unit or available on request, when designing an installation.
For the location of fixing points, weight distribution and coordinates of the centre of gravity refer to the certified dimensional drawings.
- B In multiple-chiller installations (maximum four units),** the side clearance between the units should be increased from 1000 to 2000 mm.
- C The height of the solid surface must not exceed 2 m.**



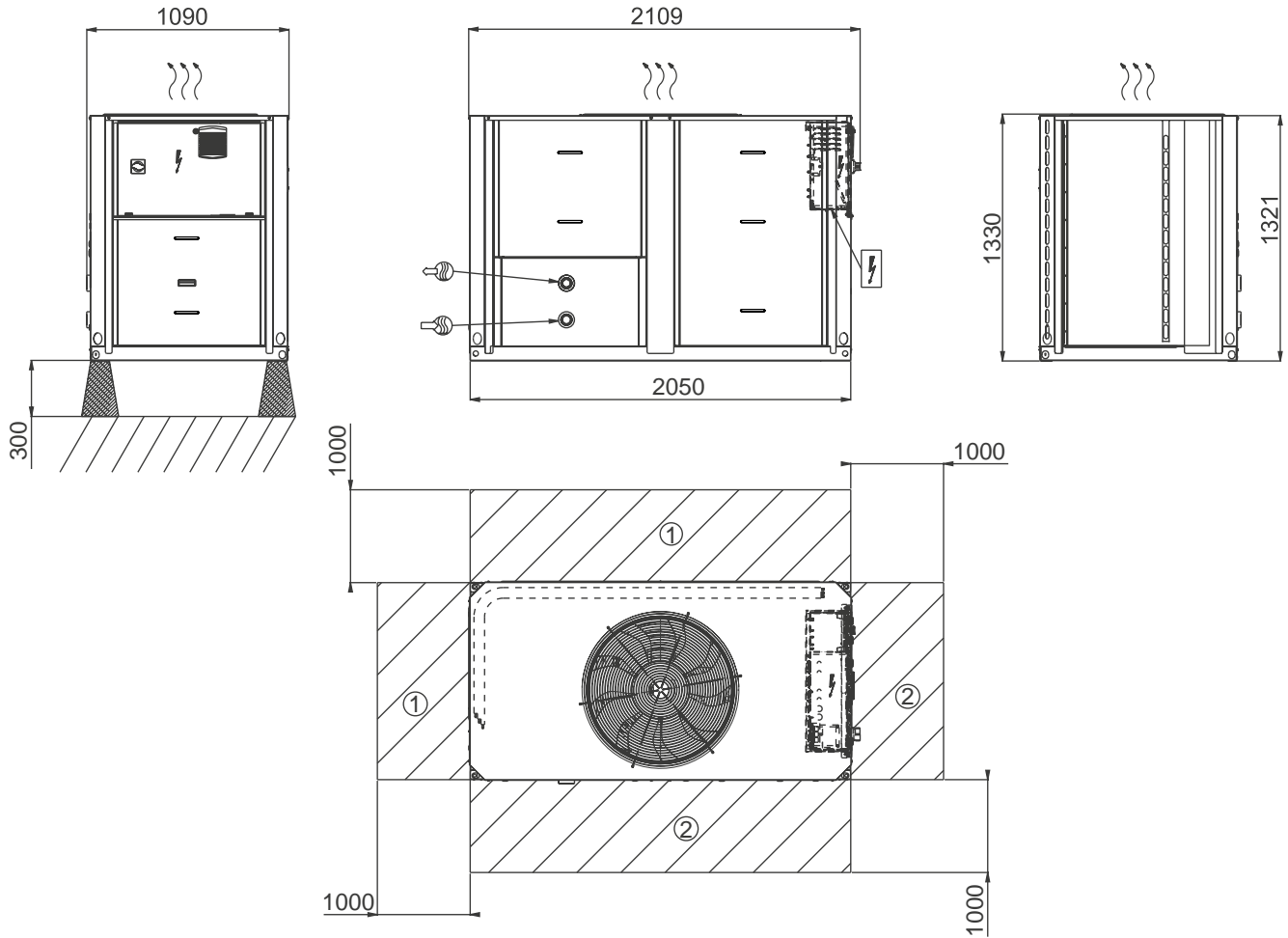

DIMENSIONS/CLEARANCES, 30RQS

30RQS 039-078, units with and without hydraulic module



Legend:

All dimensions are given in mm

-  Control box
-  Water inlet
-  Water outlet
- ① Required clearances for air entry
- ② Recommended space for maintenance
-  Air outlet, do not obstruct
-  Power supply inlet

NOTES:

- A Non-certified drawings.**
Refer to the certified dimensional drawings supplied with the unit or available on request, when designing an installation.
For the location of fixing points, weight distribution and coordinates of the centre of gravity refer to the certified dimensional drawings.
- B In multiple-chiller installations (maximum four units), the side clearance between the units should be increased from 1000 to 2000 mm.**
- C The height of the solid surface must not exceed 2 m.**





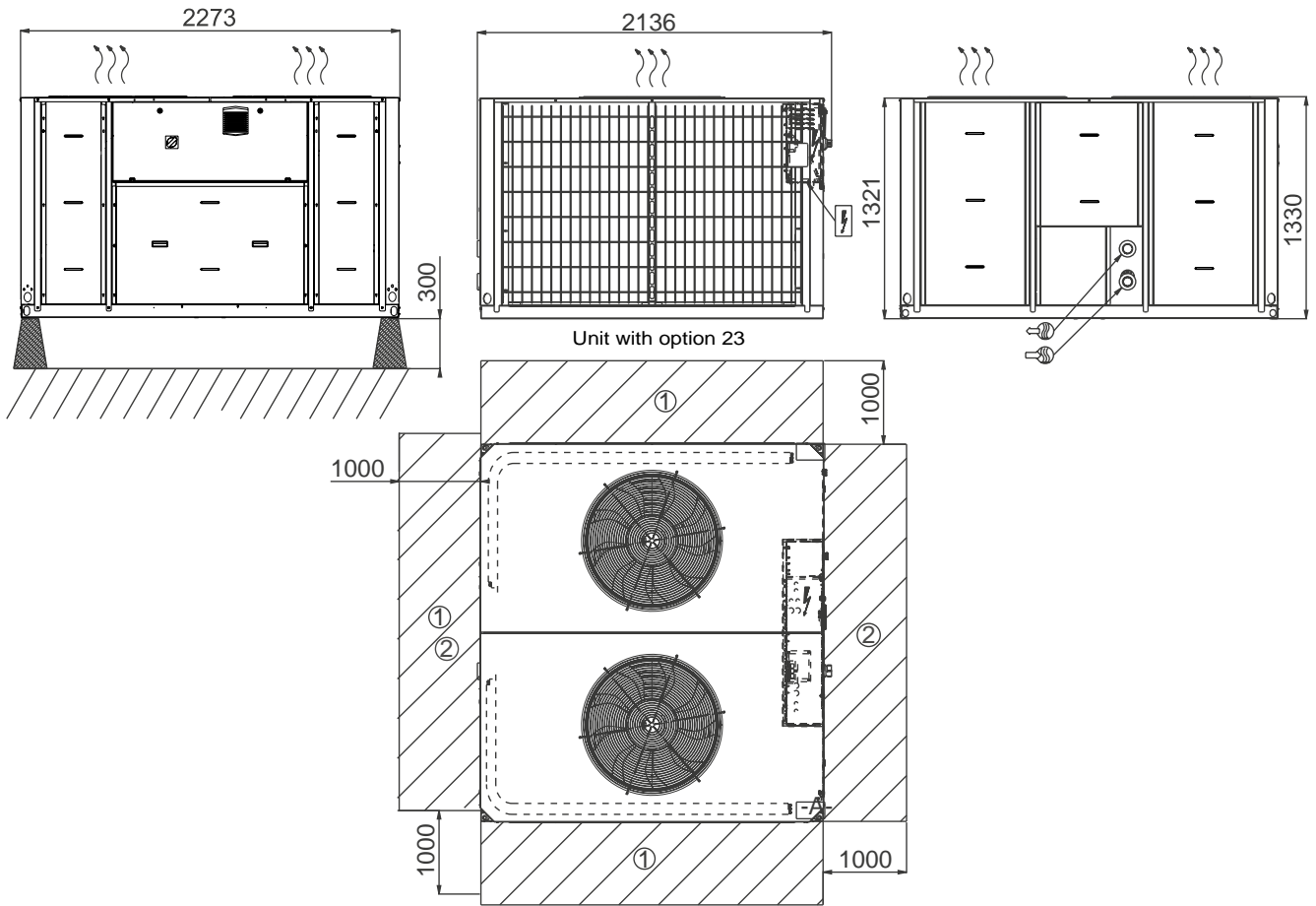

DIMENSIONS/CLEARANCES, 30RQS

30RQS 080-160, units with and without hydraulic module



Legend:

All dimensions are given in mm

-  Control box
-  Water inlet
-  Water outlet
-  Required clearances for air entry
-  Recommended space for maintenance
-  Air outlet, do not obstruct
-  Power supply inlet

NOTES:

- A Non-certified drawings.**
Refer to the certified dimensional drawings supplied with the unit or available on request, when designing an installation.
For the location of fixing points, weight distribution and coordinates of the centre of gravity refer to the certified dimensional drawings.
- B In multiple-chiller installations (maximum four units),** the side clearance between the units should be increased from 1000 to 2000 mm.
- C The height of the solid surface must not exceed 2 m.**

DIMENSIONS/CLEARANCES FOR 30RBS/RQS UNITS WITH OPTION 49

Position of the desuperheater inlets and outlets

30RBS/RQS 039-080

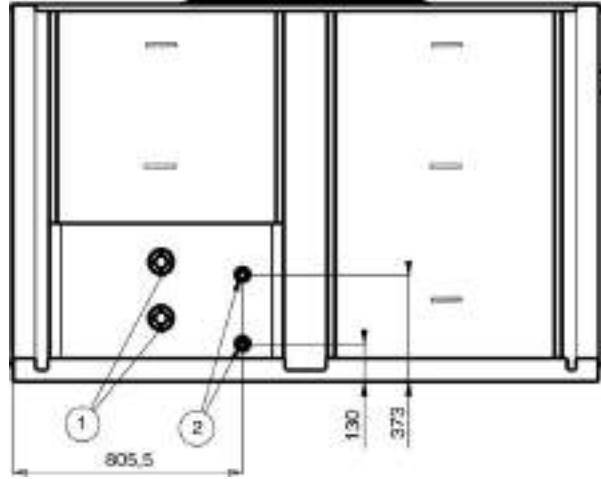

30RBS/RQS 090-120

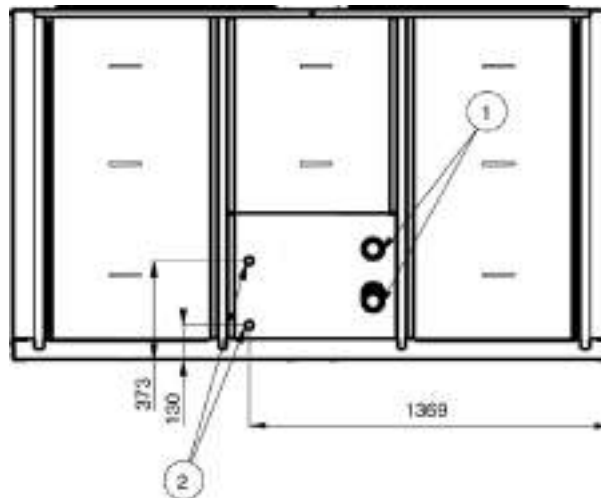

30RBS/RQS 140-160

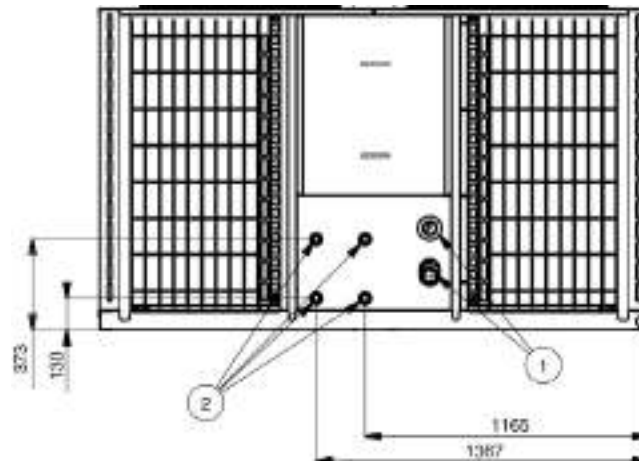

Unit with option 23

- ① Unit water inlet and outlet
- ② Water inlet and outlet, unit with option 49



Order No.: 13461, 09.2018. Supersedes order No.: 13461, 01.2018.
Manufacturer reserves the right to change any product specifications without notice.
The illustrations in this document are for illustrative purposes only and not part of any offer for sale or contract. The manufacturer reserves the right to change the design at any time without notice.

Manufactured by: Carrier SCS, Montluel, France.
Printed in the European Union.



Quality and Environment
Management Systems
Approval